



*Big*Gates

BL - PR

*portões de rua, gradeamentos
e tapa vistas*

LOU / ALU

Big Gates





PR - BL - Alas 95

portões de rua e gradeamentos

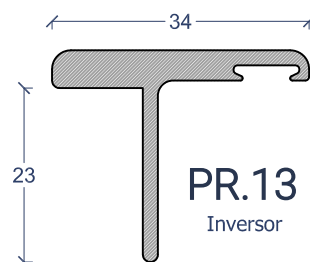
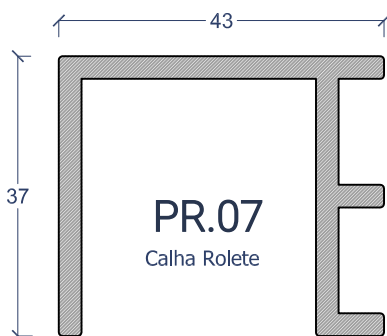
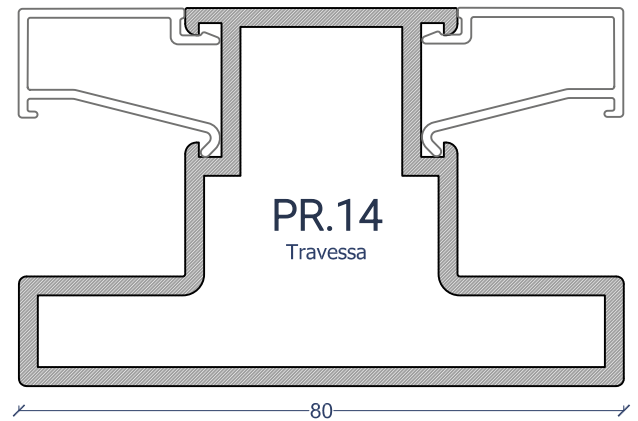
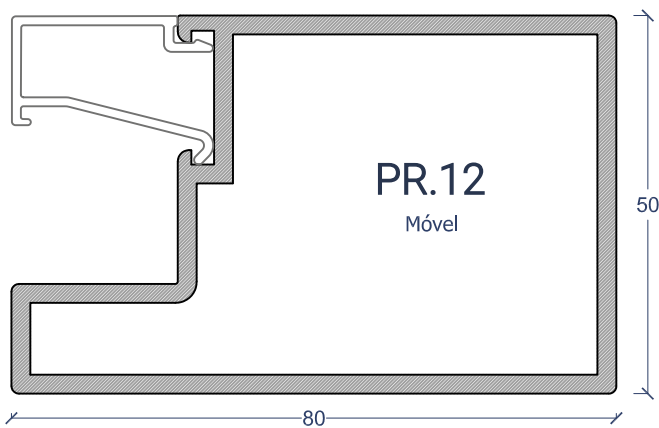
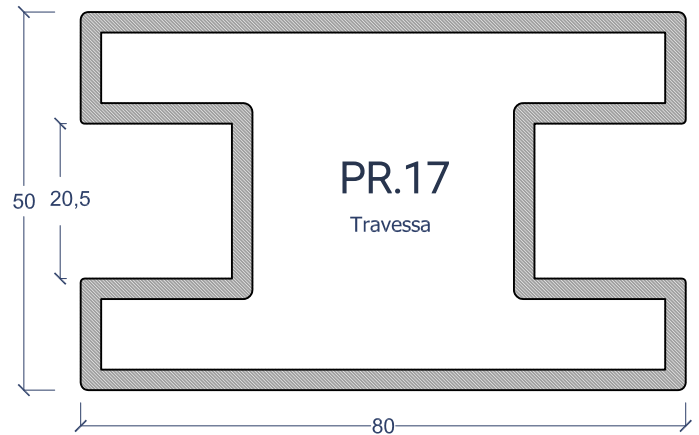
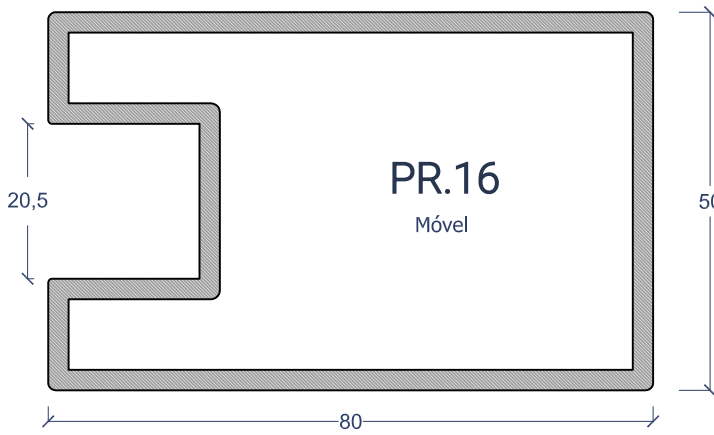
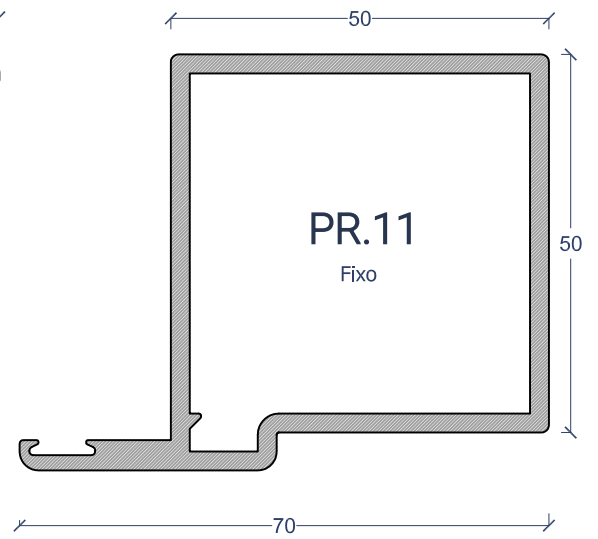
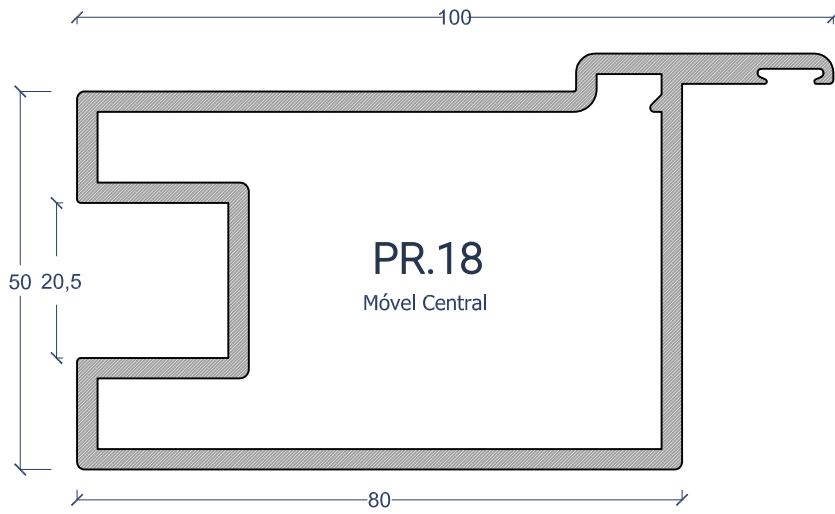

PR - portões de rua



<p>X.40.0002 Pelúcia 7.0 x 6.0</p> 	<p>X.42.0014 Vedante de Batente</p> 
<p>X.24.0007 Dobradiça soldar 3 abas</p> 	<p>X.56.0051 Tampa alumínio PR.11</p> 
	<p>X.50.0083 Tampa Nylon PR.11</p> 

PR - portões de rua

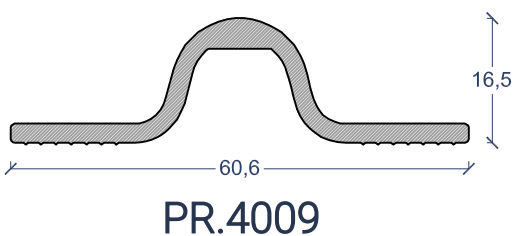
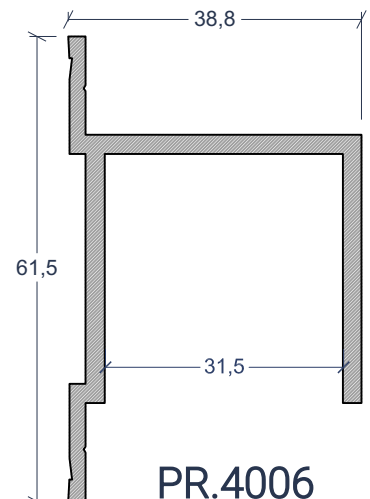
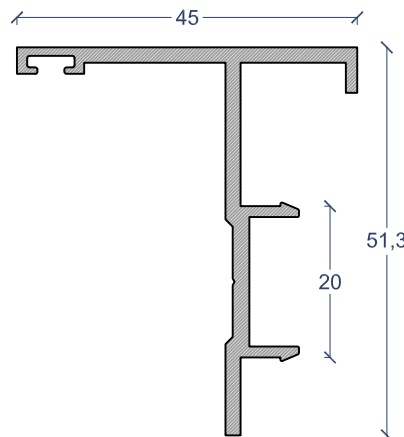
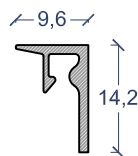
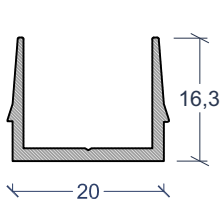
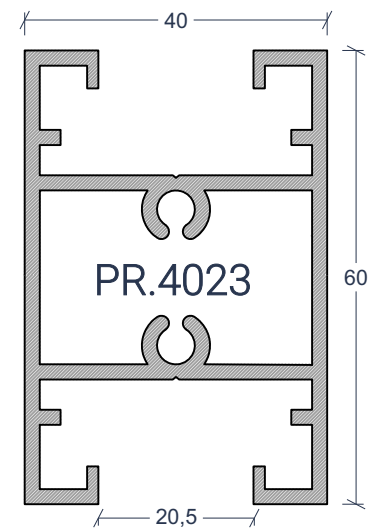
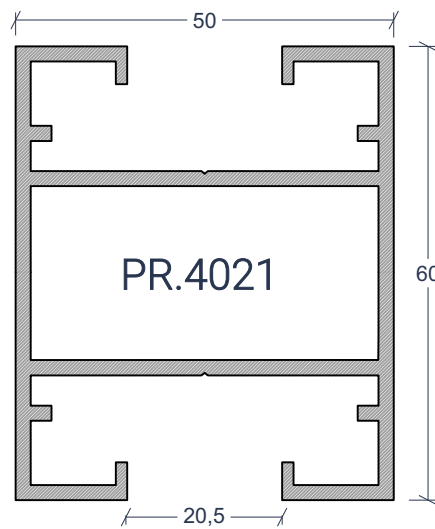
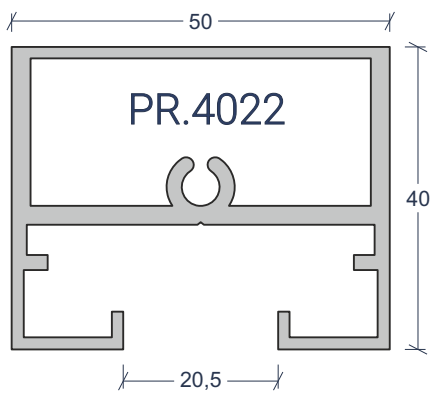
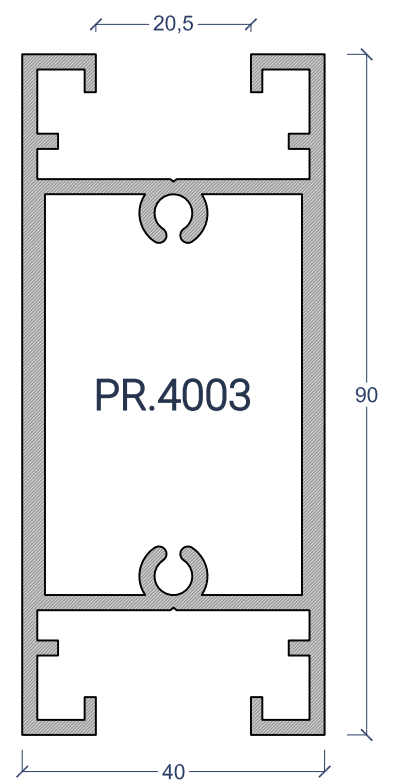
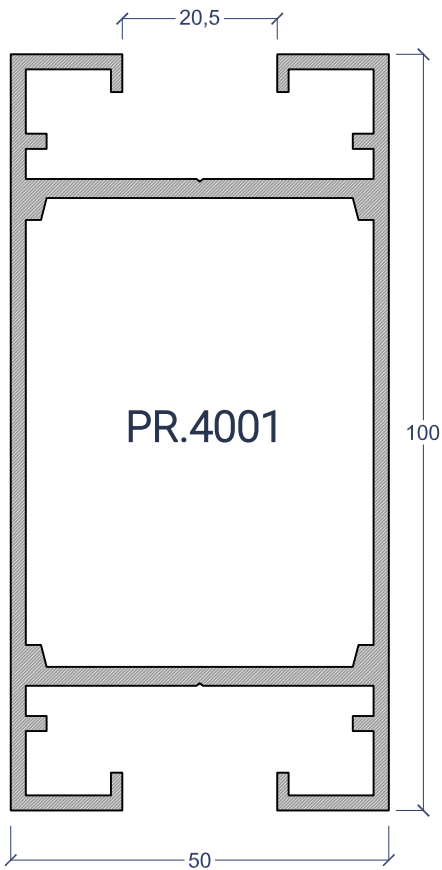

PR.4004

PR.4006

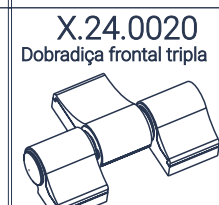
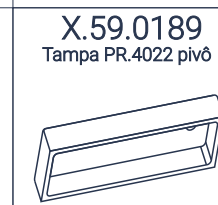
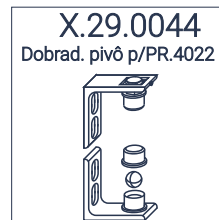
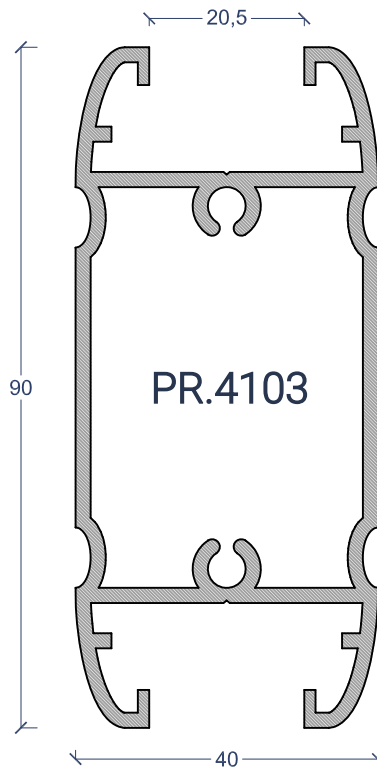
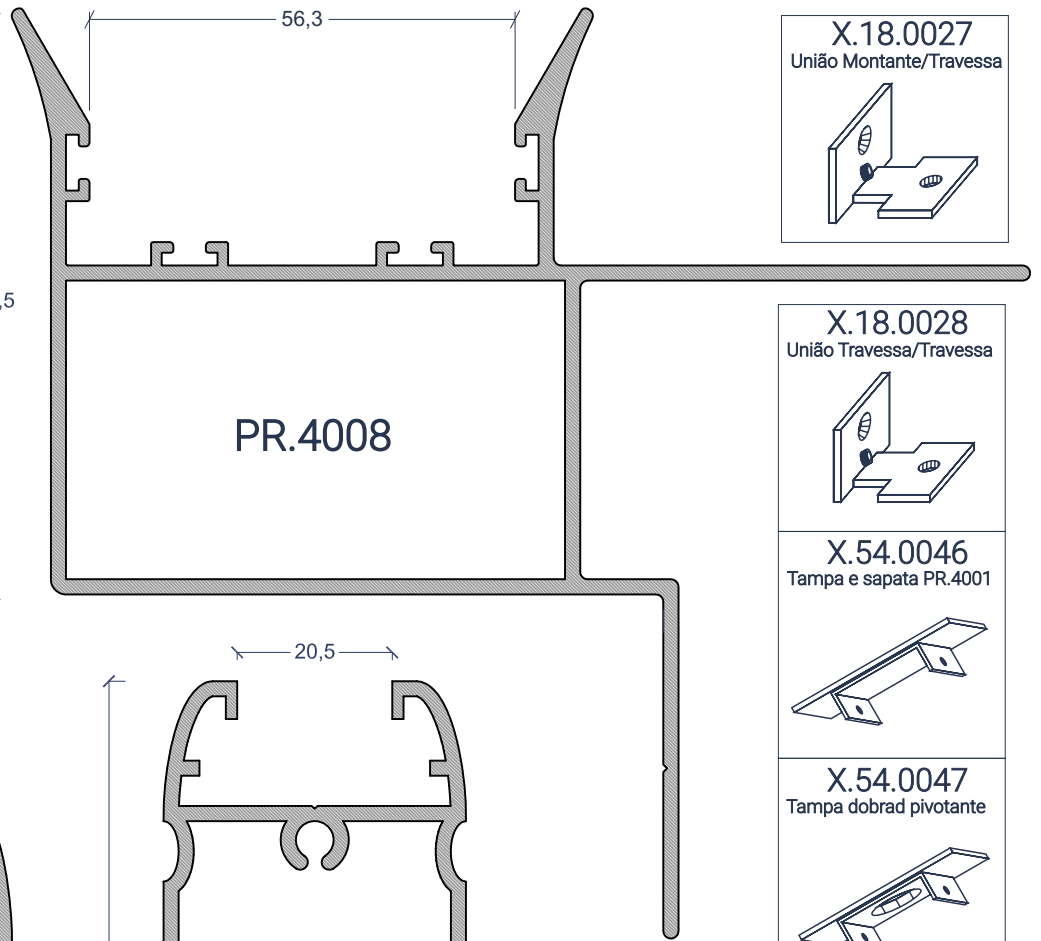
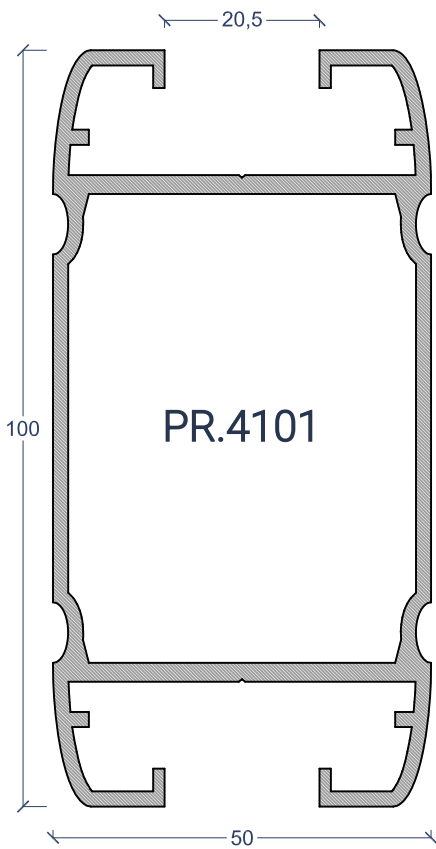
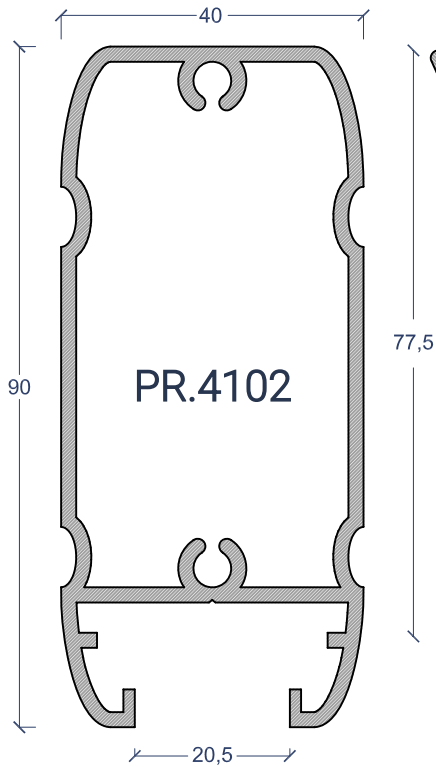

PR - portões de rua

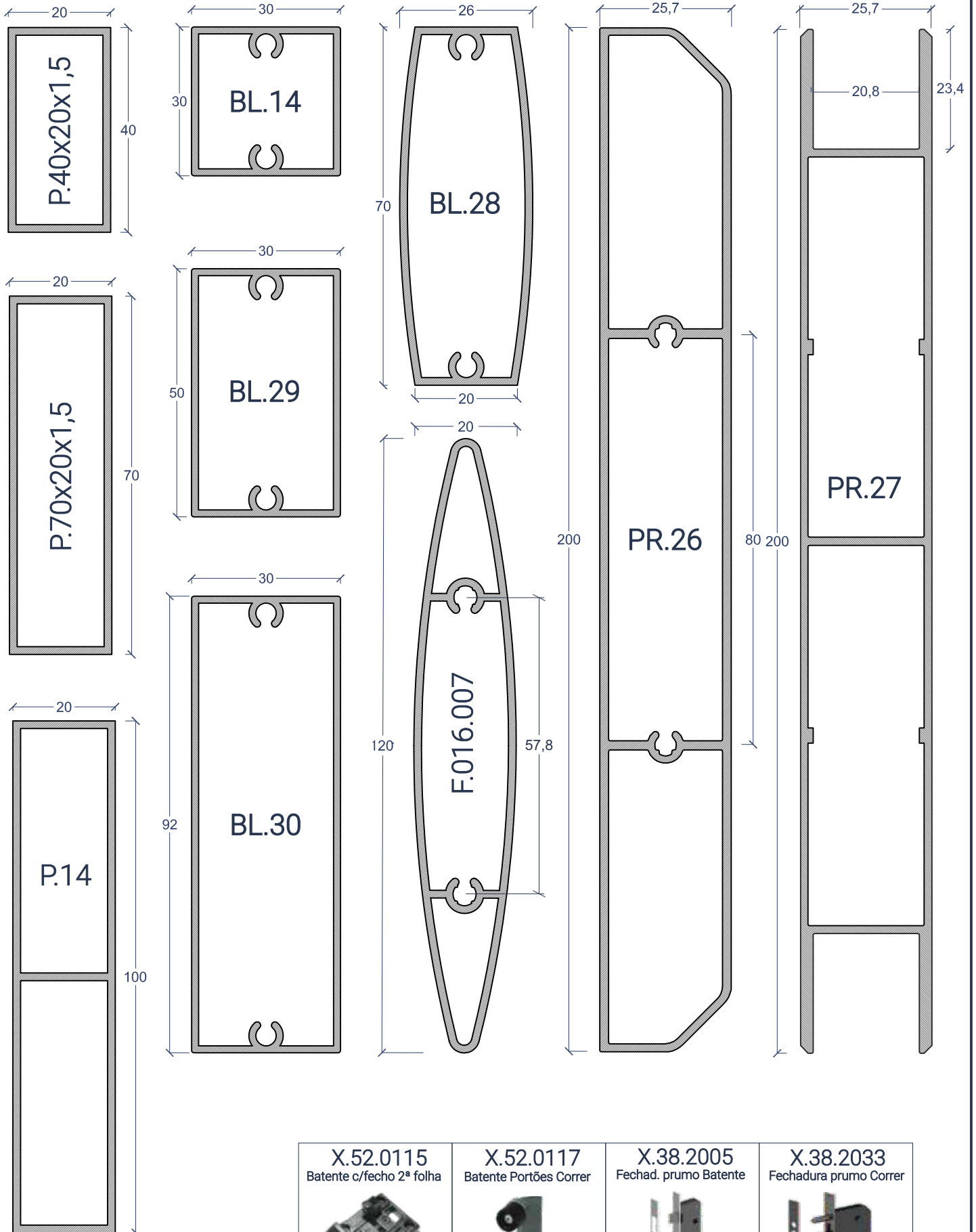

<p>X.52.0115 Batente c/fecho 2ª folha</p> 	<p>X.52.0117 Batente Portões Correr</p> 	<p>X.38.2005 Fechad. prumo Batente</p> 	<p>X.38.2033 Fechadura prumo Correr</p> 
--	--	---	--

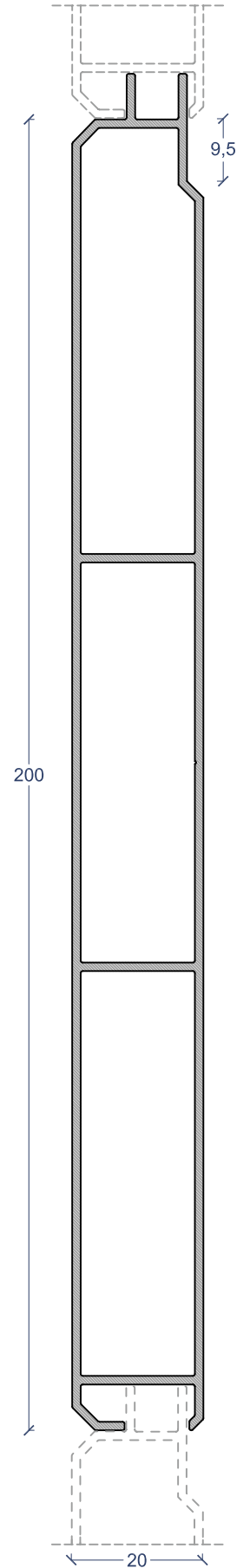
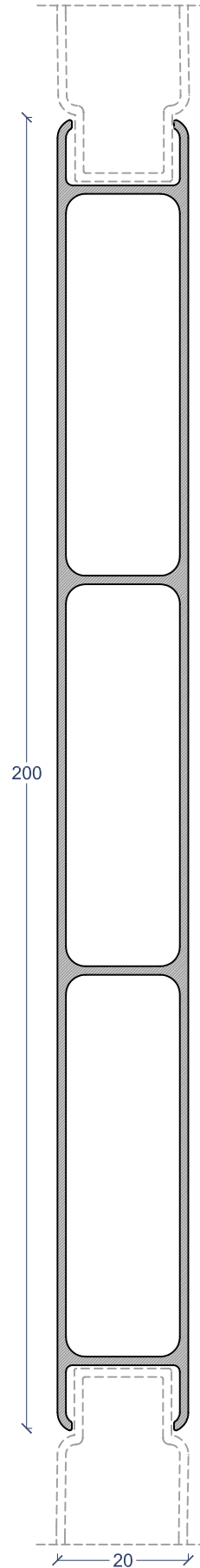
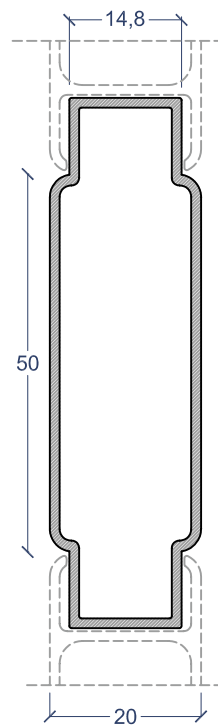
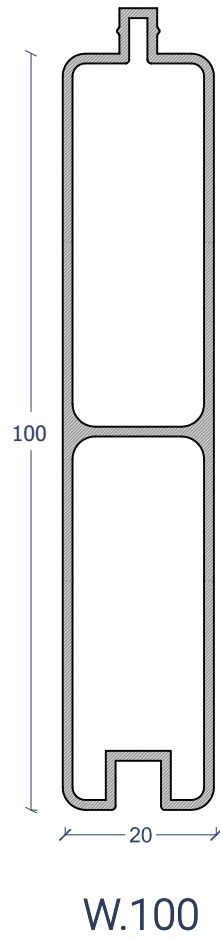
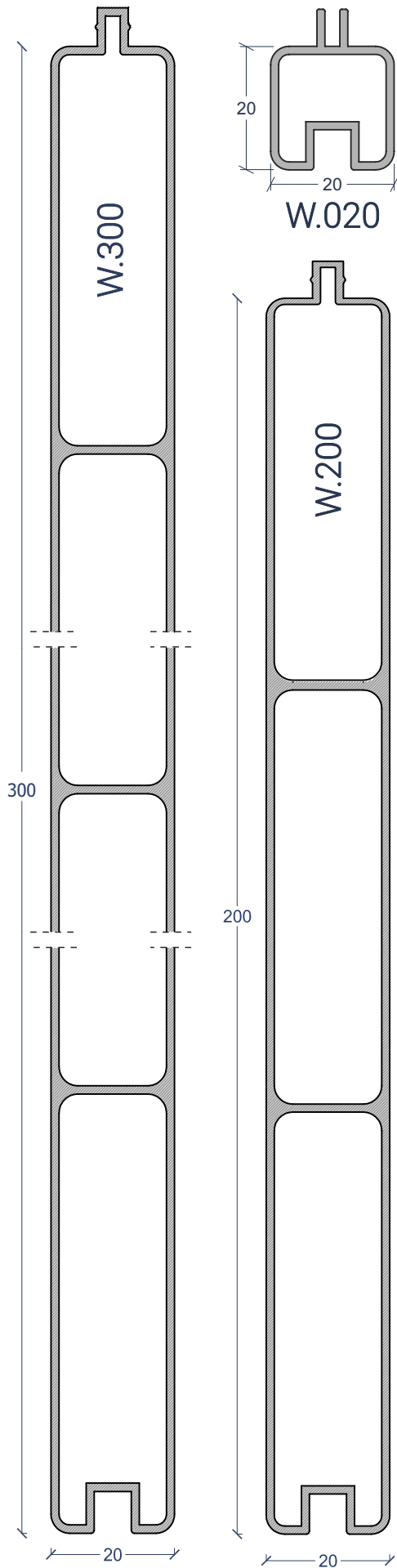

PR - portões de rua

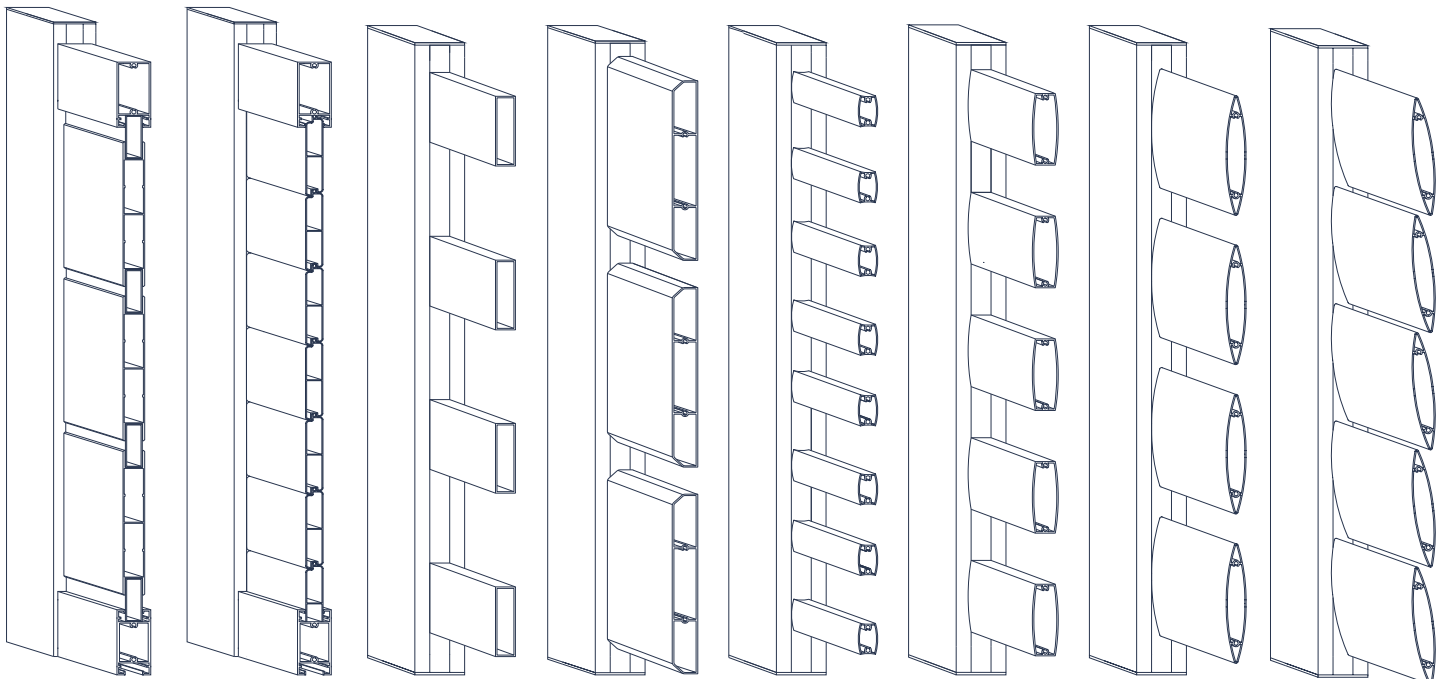
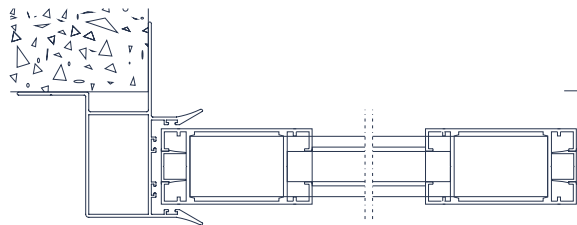
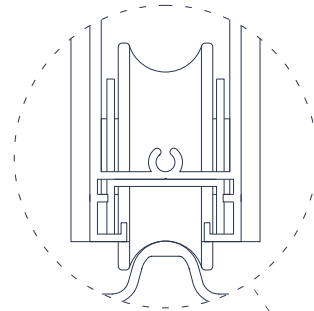
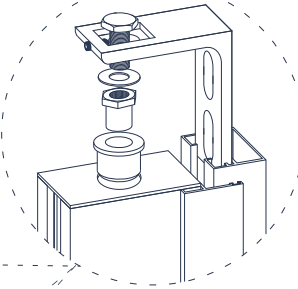
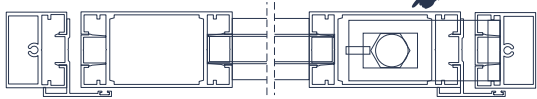
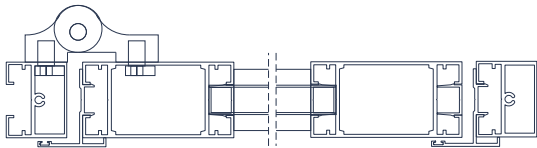
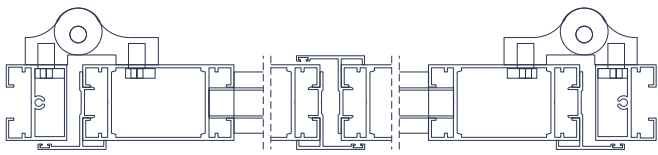
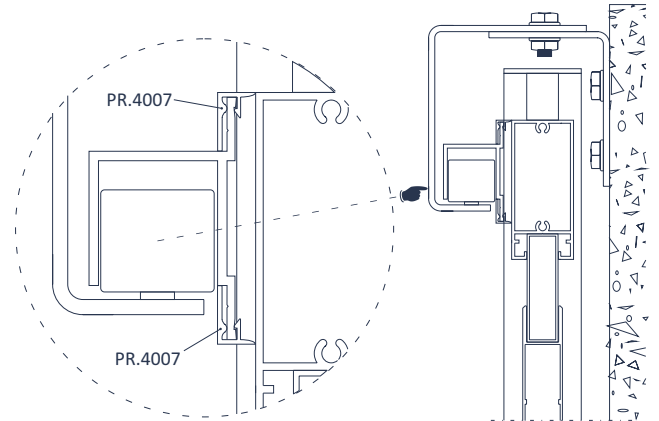
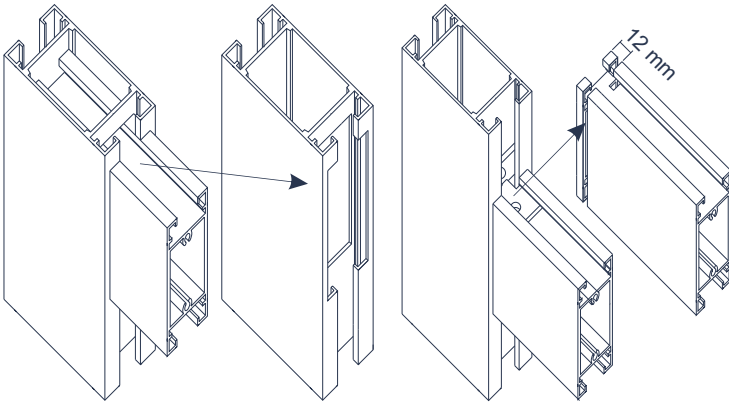

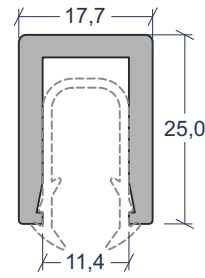
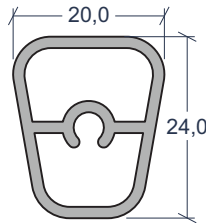
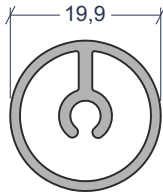
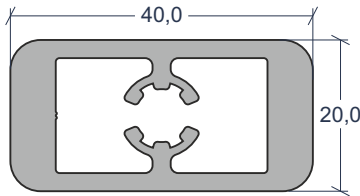
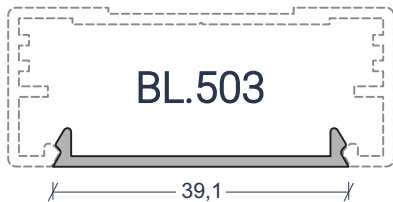
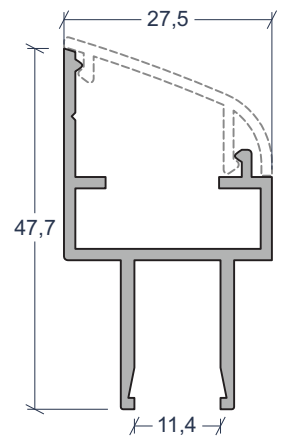
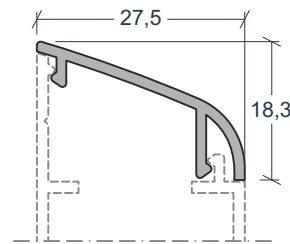
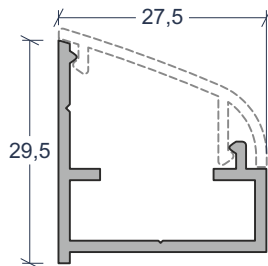
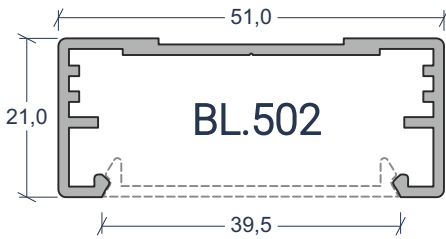
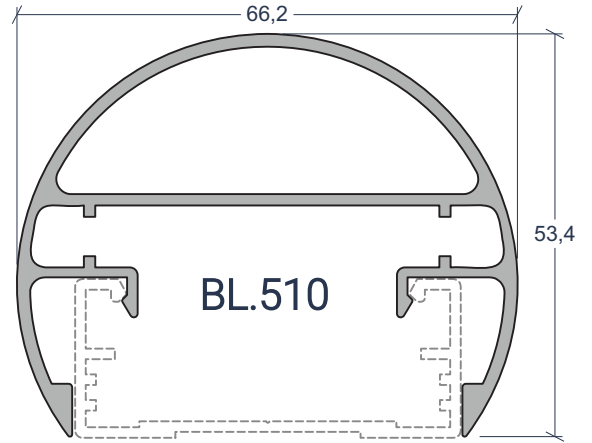
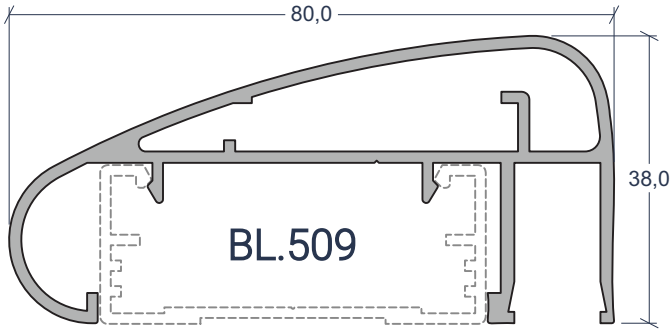

X.46.0105
Vedante para vidro 4.4

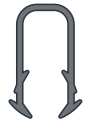

<p>X.56.0028 Tampa BL.510</p>	<p>X.56.0014 Tampa BL.509</p>	<p>X.19.0051 Esq.ang.horizont BL.502</p>	<p>X.59.0052 Esq.ang.Vertical BL.502</p>	<p>X.59.0082 Sapata Frontal BL.507</p>	<p>X.59.0083 Sapata Base BL.507</p> <p>Só lacados</p>
<p>X.54.0047 Tampa BL.502</p>	<p>X.56.0015 Tampa BL.504/506</p>	<p>X.19.0053 Esq.ang.horizont BL.504/5</p>	<p>X.19.0054 Esq.ang.Vertical BL.504/5</p>	<p>X.590077 Sapata Frontal BL.507</p>	<p>X.59.0191 Suporte BL.507p/511 regul.</p>
<p>X.59.0192 Fixador Topo BL.502</p>	<p>X.59.0193 Suporte parede BL.502</p>	<p>X.59.0194 Fixador Angular BL.502</p>	<p>X.19.0055 Esq.ang.Horz 90° BL.502</p>	<p>X.56.0049 Tampa sapata frontal</p>	<p>X.59.0190 Suporte BL.507 p/ BL.511</p>

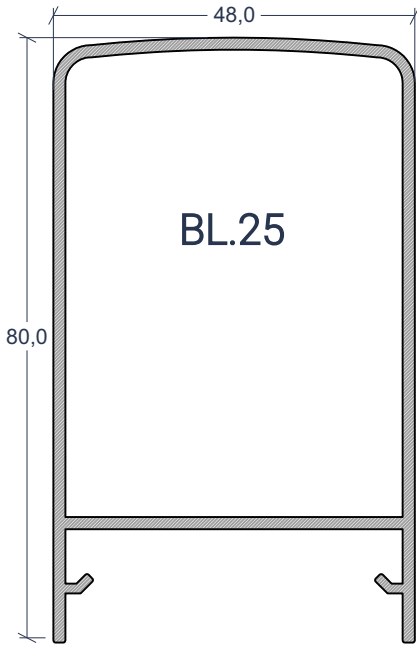

BL.25

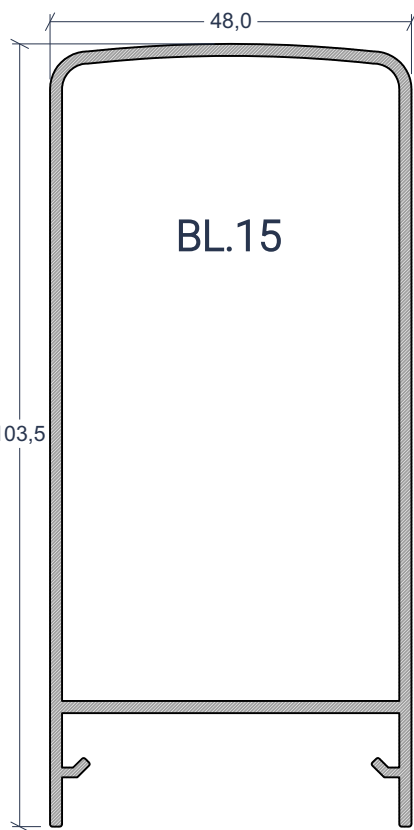

BL.15

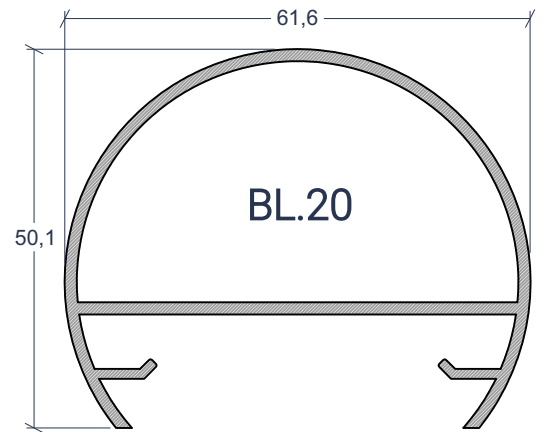

BL.20

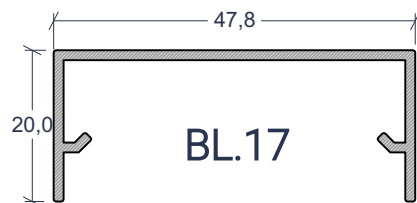

BL.17

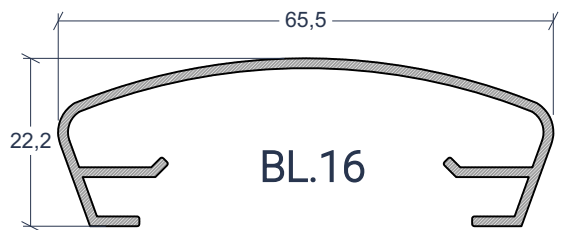

BL.16

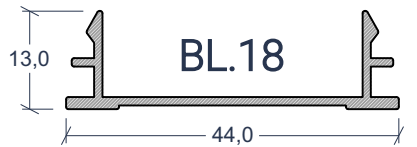

BL.18

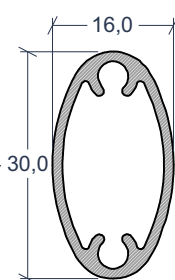

BL.27

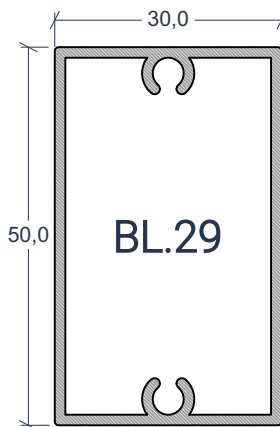

BL.29

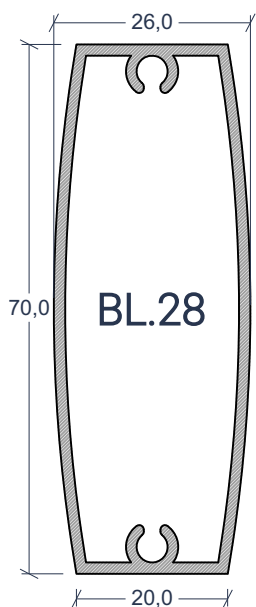

BL.28

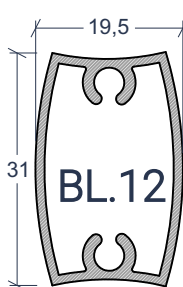

BL.12

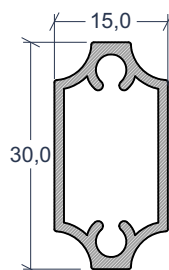

BL.11

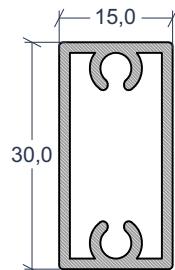

BL.13

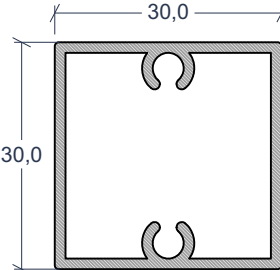

BL.14

<p>X.54.0011 Sapata base BL.14</p> <p>Alumínio fundido</p>	<p>X.54.0009 Remate Bola Q.65x2</p> <p>Alumínio fundido</p>
<p>X.54.0031 Espelho Sapata BL.14</p> <p>Alumínio fundido</p>	<p>X.54.0072 Remate piramide Q.65x2</p> <p>Alumínio fundido</p>
<p>X.54.0068 Sapata frontal BL.14</p> <p>Alumínio fundido</p>	<p>X.54.0010 Sapata Base Q.65x2</p> <p>Alumínio fundido</p>
<p>X.50.0057 Tampa BL.14</p> <p>PVC</p>	<p>X.54.0087 Espelho Sapata P.65x2</p> <p>Alumínio fundido</p>
<p>X.50.0012 Tampa P.14 (100x20)</p> <p>PVC</p>	<p>X.50.0015 Tampa P.75x40x1,5</p> <p>PVC</p>
<p>X.50.0016 Tampa P.40x20x1,5</p> <p>PVC</p>	<p>X.50.0013 Tampa Q.20x1,5</p> <p>PVC</p>
<p>X.50.0014 Tampa BL.13</p> <p>PVC</p>	<p>X.50.0030 Tampa Q.65x2</p> <p>PVC</p>